

PRESSURE SUSTAINING VALVE PS46

DESCRIPTION

The ADCA PS46 series pressure sustaining valves are single seated, diaphragm or piston sensing bellows sealed controllers, that operate without auxiliary energy.

These valves are designed for use with steam, compressed air, and other gases compatible with the construction.

They are particularly suitable for sustaining steam pressure in all energy and process systems where minimum upstream pressures must be kept under control.

MAIN FEATURES

Specially designed high durability bellows, providing pressure balancing and frictionless plug stem.

Robust construction (fit-and-forget).

Interchangeable actuators and adjustment springs.

- OPTIONS:**
- Soft sealing version in PTFE/GR for use with steam.
 - Nitrile rubber soft sealing version for air and gas applications where tight shut-off is required.
 - Low-noise flow divider.

- USE:**
- Steam, compressed air and other gases compatible with the construction. Limited use with liquids. Consult manufacturer before installing the valve with liquids.

- AVAILABLE MODELS:**
- PS46S and PS46ST or N – PN 16 or PN 40 carbon steel.
 - Suffix T: soft sealed with PTFE/GR.
 - Suffix N: soft sealed with nitrile rubber.

- SIZES:** DN 15 to DN 100.

- CONNECTIONS:** Flanged EN 1092-1 PN 16 or PN 40.
Standard PN 16 DN 65 flanges are supplied with 4 holes. 8 holes, according to EN 1092-1/-2 on request.

- AVAILABLE ACTUATORS:** A1A, A11A, A3A, A4A and P55 – carbon steel.
A2A and A21A – SG iron or carbon steel.

- INSTALLATION:** See IMI – Installation and maintenance instructions.



**PS46
with sensing pipe
on body**

CE MARKING – GROUP 2 (PED – European Directive)		
PN 16	PN 40	Category
DN 15 to 50	DN 15 to 32	SEP
DN 65 to 150	DN 40 to 100	1 (CE marked)

LIMITING CONDITIONS

Valve model	PS46S	PS46S	PS46ST	PS46ST	PS46SN	PS46SN
Body design conditions	PN 16	PN 40	PN 16	PN 40	PN 16	PN 40
Maximum upstream pressure	13 bar	18 bar	13 bar	18 bar	13 bar	18 bar
Maximum downstream pressure	13 bar	18 bar	13 bar	18 bar	13 bar	18 bar
Minimum upstream pressure	0,2 bar	0,2 bar	0,2 bar	0,2 bar	0,2 bar	0,2 bar
Maximum operating temperature	200 °C	250 °C	200 °C	200 °C	80 °C	80 °C
Maximum hydraulic factory valve body test	24 bar	60 bar	24 bar	60 bar	24 bar	60 bar

Remarks: Other soft materials and temperature limits on request.

Warning: A pressure sustaining valve is not a safety relief valve and must not be used for that purpose!

Actuator model	A1A	A11A	A2A	A21A	A3A	A4A	P55
Maximum operating pressure (bar)	25	25	12	18	2,5	1,5	25
Maximum operating temperature *	90 °C						130 °C

* A water seal pot must be installed in the sensing pipe when operating with steam or liquids at higher temperatures.

FLOW RATE COEFFICIENTS (m³/h)

SIZE	DN 15	DN 20	DN 25	DN 32	DN 40	DN 50	DN 65	DN 80	DN 100
Kvs	4,8	6,9	9,1	11,8	14,4	26,5	51,5	79,5	129,5

ACTUATOR AND SPRING SELECTION TABLE

SIZE	ACTUATOR								
		A4A	A3A	A2A	A21A	A1A	A11A	P55	
DN 15	Spring range (bar)	0,2-0,45	0,45-0,9	0,75-1,6	1,6-3,2	2,4-5	3,5-7	4,5-10	9-18
	Spring N°	66	60	60	60	60	60	60	60
DN 20	Spring range (bar)	0,2-0,45	0,45-0,9	0,75-1,6	1,6-3,2	2,4-5	3,5-7	4,5-10	9-18
	Spring N°	66	60	60	60	60	60	60	60
DN 25	Spring range (bar)	0,2-0,45	0,45-0,9	0,75-1,6	1,6-3,2	2,4-5	3,5-7	4,5-10	9-18
	Spring N°	66	60	60	60	60	60	60	60
DN 32	Spring range (bar)	0,2-0,45	0,45-0,9	0,75-1,5	1,5-3	2,1-4,5	3-6,5	4,5-9	8-16
	Spring N°	66	60	60	60	60	60	60	60
DN 40	Spring range (bar)	0,2-0,45	0,45-0,9	0,75-1,5	1,5-3	2,1-4,5	3-6,5	4,5-9	8-16
	Spring N°	66	60	60	60	60	60	60	60
DN 50	Spring range (bar)	0,2-0,4	0,3-0,9	0,5-1,5	1-3,2	1,4-4,8	2,5-7	3-10	8-18
	Spring N°	67	61	61	61	61	61	61	61
DN 65	Spring range (bar)	0,2-0,4	0,3-0,9	0,5-1,5	1-3,2	1,4-4,8	2,5-7	3-10	8-18
	Spring N°	67	61	61	61	61	61	61	61
DN 80	Spring range (bar)	0,2-0,4	0,3-0,9	0,4-1,4	0,6-3	0,8-4,2	2-6	3-8	6-16
	Spring N°	68	62	62	62	62	62	62	62
DN 100	Spring range (bar)	0,2-0,4	0,3-0,9	0,4-1,4	0,6-3	0,8-4,2	2-6	3-8	6-18
	Spring N°	69	63	63	63	63	63	63	63

HOW TO SIZE (USING Kvs)

Please consult formulas on IS PV10.00 E or consult manufacturer.

ORDER REQUIREMENTS

Remarks: Never size the valve according to the pipe diameter in which it has to be fitted, but according to the actual flow required. Pipe sizing must also respect the maximum recommended flow velocities, according to the medium.

HOW TO ORDER

PS46 DN 32 PN 16 valve complete with spring N° 60, A2A actuator, condensate vessel and copper sensing pipe.

INSTALLATION

Horizontal installation with the actuator vertically, pointing downwards.

Installation with the actuator pointing upwards is possible only when the medium temperature is below 90 °C.

The sensing pipe, if not fitted on the valve body, must be installed upstream of the valve at a minimum of 1 meter away or 15 pipe diameters.

In steam applications, a “Y” strainer, humidity separator and steam trap should be installed upstream of the valve.

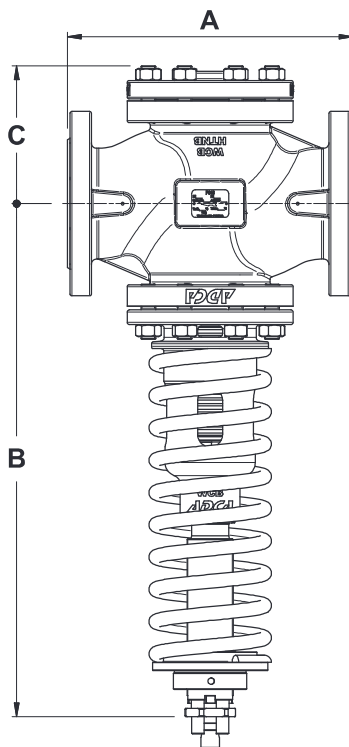

DIMENSIONS – VALVE (mm)									
DIMENSION	SIZE								
	DN 15	DN 20	DN 25	DN 32	DN 40	DN 50	DN 65	DN 80	DN 100
A	130	150	160	180	200	230	290	310	350
B	366	369	371	381	384	470	495	556	597
C	81	84	86	95	100	113	150	150	164
WEIGHT (kg)	10,4	11,8	12,3	15,2	18,6	24,6	41,1	55,1	69,8

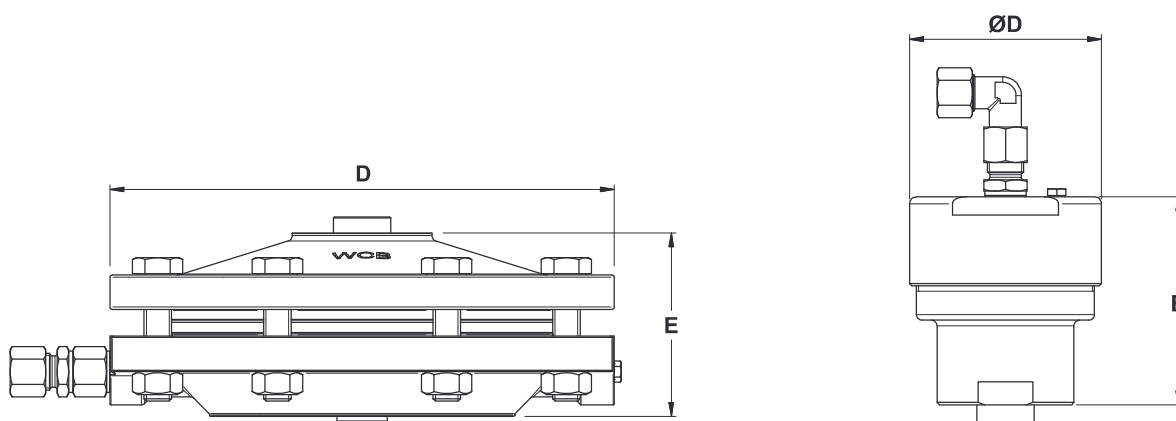

DIMENSIONS – ACTUATOR (mm)					
DIMENSION	ACTUATOR				
	A1A / A11A	A2A / A21A	A3A	A4A	P55
D	172	220	282	340	84
E	74	80	82	92	91
WEIGHT (kg)	5,8	10,2	12,6	18,3	2,7

MATERIALS

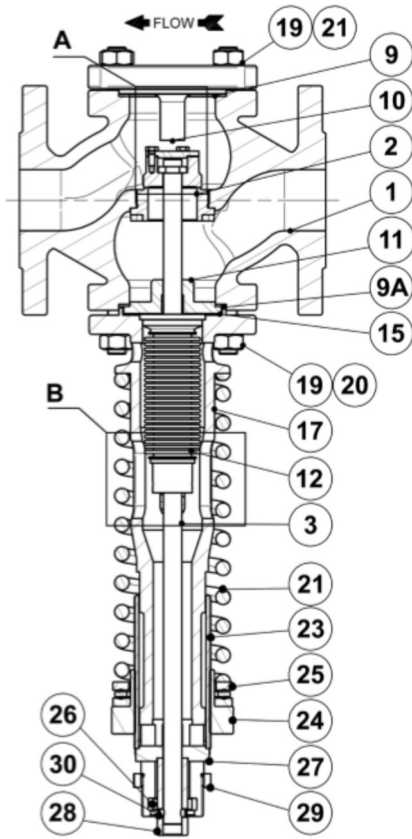

DN 15 – DN 50

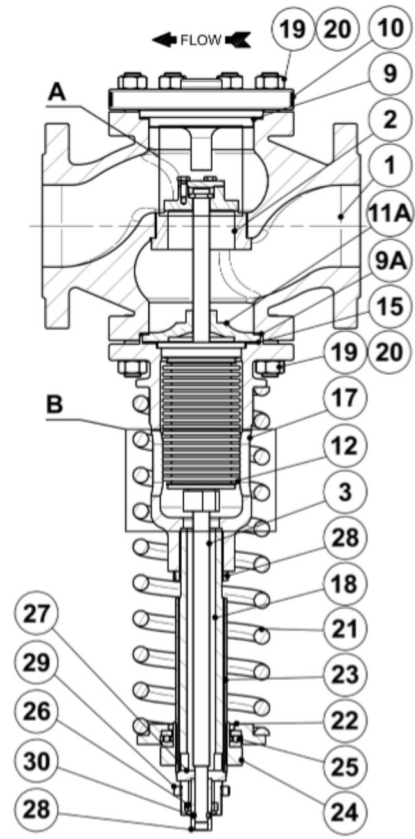

DN 65 – DN 100

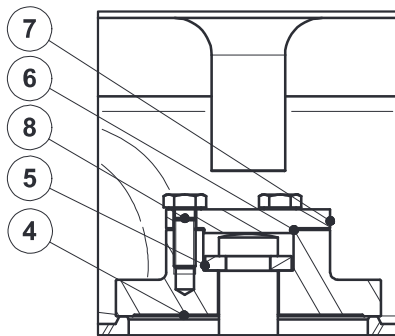

Detail A
(DN 15 - DN 100)

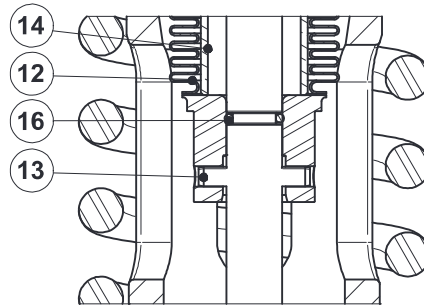

Detail B
(DN 15 - DN 65)

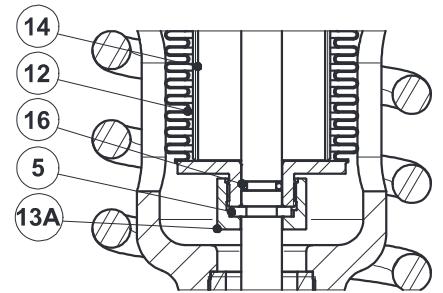

Detail B
(DN 80 - DN 100)

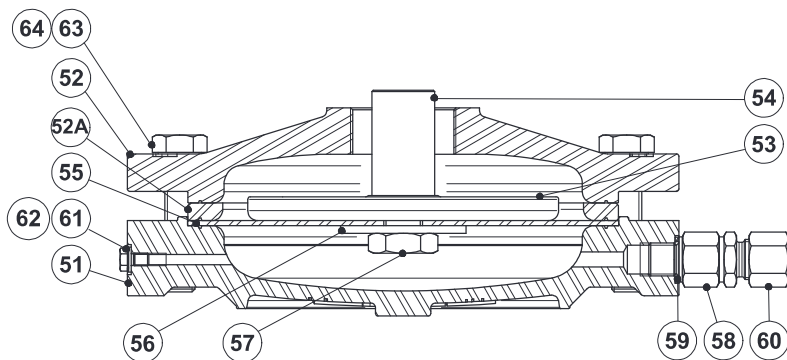

A SERIES ACTUATORS

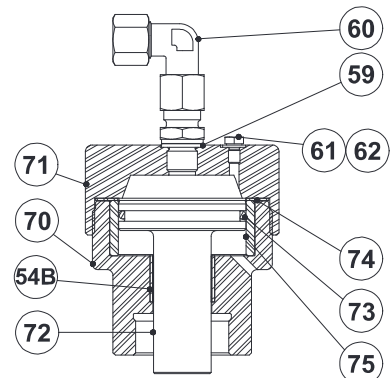

P SERIES ACTUATORS

MATERIALS – VALVE

POS. N°	DESIGNATION	DN 15 – DN 50	DN 65 – DN 100
1	Valve body	A216 WCB / 1.0619	A216 WCB / 1.0619
2	Seat	AISI 316 / 4.4401	AISI 316 / 4.4401
3	Stem	AISI 304 / 1.4301	AISI 304 / 1.4301
4	* Valve plug	AISI 420 / 1.4021	AISI 420 / 1.4021
5	Split ring	AISI 316 / 1.4401	AISI 316 / 4.4401
6	Gasket	Copper	Copper
7	Plug cover	AISI 316 / 1.4401	AISI 316 / 1.4401
8	Bolts	AISI 304 / 1.4301	AISI 304 / 1.4301
9	Gasket	Stainless steel / Graphite	Stainless steel / Graphite
9A	Gasket	Stainless steel / Graphite	Stainless steel / Graphite
10	Cover	A216 WCB / 1.0619	A216 WCB / 1.0619
11	Stem guide	AISI 304 / 1.4301	Bronze
12	Bellows	AISI 316Ti / 1.4571	AISI 316Ti / 1.4571
13	Pin	AISI 301 / 1.4310	–
13A	Nut	–	AISI 316 / 1.4401
14	Guide tube	CuZn39Pb3	CuZn39Pb3
15	Gasket	Stainless steel / Graphite	Stainless steel / Graphite
16	O-ring	EPDM	EPDM
17	Piston body	A216 WCB / 1.0619	A216 WCB / 1.0619
18	Piston body extension	–	P355T1 / 1.0421
19	Studs	34CrNiMo6 / 1.6582	34CrNiMo6 / 1.6582
20	Nuts	Zinc plated steel	Zinc plated steel
21	* Adjustment spring	Spring steel	Spring steel
22	Lower spring plate	–	C45E / 1.1191
23	Threaded tube	CuZn39Pb3	CuZn39Pb3
24	Spring adjusting nut	C45E / 1.1191	C45E / 1.1191
25	Ball bearing	Zinc plated steel	Zinc plated steel
26	Spacer	S355JR / 1.0045	S355JR / 1.0045
27	Pressure star	S235JR / 1.0038	S235JR / 1.0038
28	Pressure tube	C45E / 1.1191	C45E / 1.1191
29	Lock nut	C45E / 1.1191	C45E / 1.1191
30	Pin	AISI 303 / 1.4305	AISI 303 / 1.4305

MATERIALS – ACTUATORS

POS. N°	DESIGNATION	A1A / A11A / A3A / A4A	A2A / A21A	POS. N°	DESIGNATION	P55
51	Lower diaphragm chamber	A216 WCB / 1.0619	GJS-400-15 / 0.7040 or A216 WCB / 1.0619	54B	Guide bushing	Steel
52	Upper diaphragm chamber	A216 WCB / 1.0619	GJS-400-15 / 0.7040 or A216 WCB / 1.0619	59	Gasket	Copper
52A	Spacer ring	S355JR / 1.0045	S355JR / 1.0045	60	Compression fitting	AISI 316Ti / 1.4571
53	Pressure plate	A216 WCB / 1.0619	GJS-400-15 / 0.7040	61	Vent screw	Zinc plated steel
54	Diaph. plate spindle	A216 WCB / 1.0619	GJS-400-15 / 0.7040	62	Washer	Copper
55	* Diaphragm	Neoprene reinforced polyamid	Neoprene reinforced polyamid	70	Body	S235JR / 1.0038
56	Washer	Copper	Copper	71	Cover	S235JR / 1.0038
57	Hex nut	CuZn39Pb3	CuZn39Pb3	72	Piston	AISI 316 / 1.4401
58	Flow restrictor	AISI 303 / 1.4305	AISI 303 / 1.4305	73	* O-ring	EPDM
59	Gasket	Copper	Copper	74	* Gasket	Stainless steel / Graphite
60	Compression fitting	AISI 316Ti / 1.4571	AISI 316Ti / 1.4571	75	Piston sleeve	AISI 304 / 1.4301
61	Vent screw	Zinc plated steel	Zinc plated steel			
62	Washer	Copper	Copper			
63	Bolts	Zinc plated steel	Zinc plated steel			
64	Nuts	Zinc plated steel	Zinc plated steel			

* Available spare parts.